

Manufactured and distributed by WowWee Group Limited. Pinkfong® Baby Shark™ and all product names, designations and logos are trademarks of Smart Study Company Limited. Copyright 2019 Smart Study Company Limited. All rights reserved. Patent pending.

Customer Service Website: <https://support.wowwee.com>

We recommend that you retain our address for future reference. Product and colors may vary. Packaging printed in China.

WARNING! This product is not suitable for children under 3 years because of small parts - choking hazard.

CAN ICES-3(B)/NMB-3(B)

MADE IN CHINA

CAUTION

Changes or modifications not expressly approved by the party responsible for compliance could void the user's authority to operate the equipment.

NOTE

This equipment has been tested and found to comply with the limits for a class B digital device, pursuant to part 15 of the FCC rules. These limits are designed to provide reasonable protection against harmful interference in a residential installation. This equipment generates, uses and can radiate radio frequency energy and, if not installed and used in accordance with the instructions, may cause harmful interference to radio communications.

However, there is no guarantee that interference will not occur in a particular installation. If this equipment does cause harmful interference to radio or television reception, which can be determined by turning the equipment off and on, the user is encouraged to try and correct the interference by one or more of the following measures:

- Reorient or relocate the receiving antenna
- Increase the separation between the equipment and receiver
- Connect the equipment into an outlet on a circuit different from that to which the receiver is connected
- Consult the dealer or experienced radio/TV technician for help

This Device complies with Part 15 of the FCC Rules. Operation is subject to the following two conditions: (1) This device may not cause harmful interference, and (2) This device must accept any interference received, including interference that may cause undesired operation.

For these purposes, the party responsible is:

WowWee USA Inc.

7855 Fay Avenue, Suite 310, La Jolla CA, USA 92037

1-800-310-3033

For warranty information, please visit <http://wowwee.com/information/warranty>

WARNING!

This equipment may experience difficulty and/or memory loss when subjected to any electrostatic discharge, radio frequency interference, or sudden power surge/interruption. The user is encouraged to reset the equipment should any of these occur.



WowWee Group Limited
Energy Plaza, 301A-C
92 Granville Road
T.S.T. East, Hong Kong

WowWee Canada Inc.
3700 Saint Patrick Street
Suite 206, Montreal, QC
H4E 1A2, Canada



61266US02CBF_MIM

b britebrush™

pinkfong BABY SHARK



WowWee Group Limited.
Energy Plaza, 301A-C
92 Granville Road
T.S.T. East, Hong Kong

WowWee Canada Inc.
3700 Saint Patrick Street
Suite 206, Montreal, QC
H4E 1A2, Canada

Copyright © Smart Study Co., Ltd. All Rights Reserved.
Pinkfong® Baby Shark™ are licensed trademarks of Smart Study Co., Ltd.

Age: 3+

Customer Service:
More information on:

<https://support.wowwee.com>

USER MANUAL

Congratulations! You're the proud owner of the smartest, most fun brush ever! With games and music, BriteBrush™ has patented sensors that know if you're brushing the right way! The better you brush, the more fun you'll have!

Package Contents:

- 1 x BriteBrush™ Baby Shark™ with Brush Head,
- 1 x Extra Brush Head,
- 1 x User Manual

Required:

- 2 x 1.5V "AAA / LR03" Batteries (included)

POWER ON/OFF

Press the button to turn on your BriteBrush™. Your BriteBrush™ will automatically power off after a game or if you don't brush for a while. Press and hold the button for several seconds at any time to turn it off (you will hear a power down sound).

TRY ME MODE:

When you first take the brush out of the package, it will be in 'Try me' mode. After pressing the button, you will hear audio about the brush. Just start brushing up and down, during or after the audio, and you will start a brief practice session for brushing correctly. After you finish the practice session the brush will enter its normal operation mode as described on the next page.

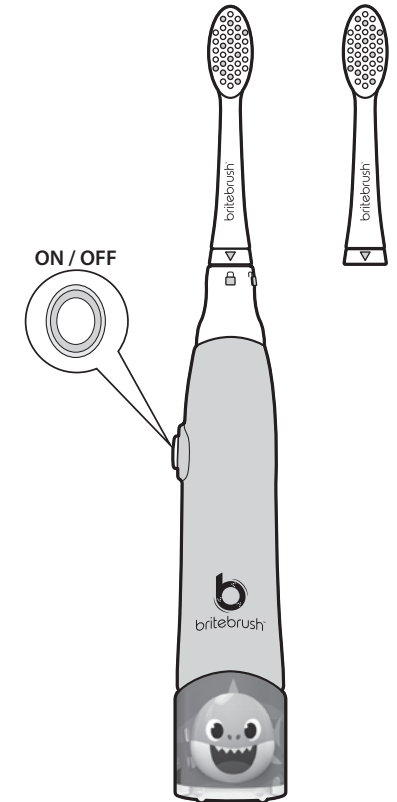

PLAYING GAMES AND SOUNDS

After turning on your BriteBrush™, press the button to choose one of three modes:

- **Practice** – Work on your brushing technique with fun sounds and lights!
- **Baby Shark™ Song** – Go on a musical adventure with Baby Shark™ and his family!
- **Treasure Hunt Game** – Go on a swimming adventure to find treasures! Play it again and again with different outcomes!

Each game has four sections. See if you can get all 10 stars! Your score is based on how well you brush and follow the instructions for changing sides! If you brush really well, you might win a bonus treasure! The Baby Shark™ Song and Treasure Hunt Game each last about a minute. Play twice for approximately 2 minutes of brushing, the amount of time recommended by dentists.

Remember: Brushing up and down or in small circles will keep the games going!

Volume Control

To play the games with lower volume, press the button to turn on your BriteBrush™ and continue holding the button for two seconds until you feel a vibration. Then release the button. You can now brush with a lower volume level.

Score Check / Parent Check Light

To hear the last recorded score, quickly double press the button when your BriteBrush™ is off. This will also activate the Parent Check Light.

- Green Light:** Complete
- Yellow Light:** Good Effort
- Red Light:** Incomplete

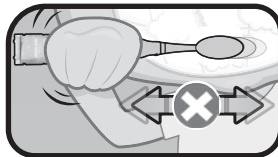
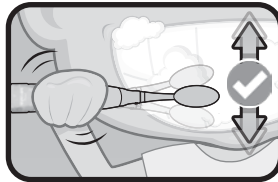
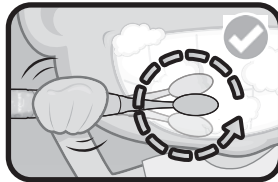
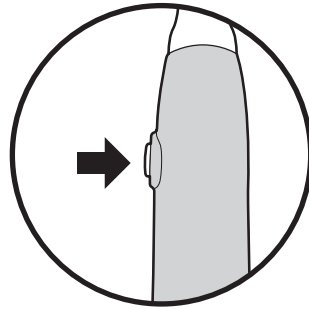

CHANGING BRUSH HEAD

Removing a Brush Head

1. Rotate the brush head until the triangle arrow points to the “unlocked” icon.
2. Pull the brush head off the brush.

*We recommend changing your brush head every 3 months.

Attaching a Brush Head

1. Put your BriteBrush™ brush head onto the brush, so the triangle arrow points to the “unlocked” icon.
2. Rotate the brush so the triangle arrow points to the “locked” icon, and you will feel it lock into position.

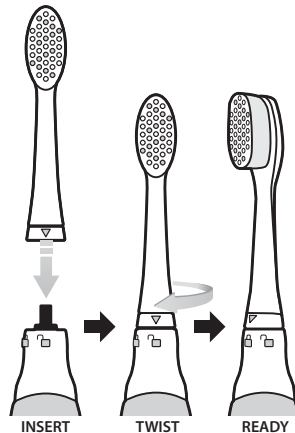

REPLACING BATTERIES

1. Using an eyeglasses screwdriver, remove the small screw near the base of your BriteBrush™.
2. Pull down on the bottom ring of the brush to slide out the electronics.
3. Replace the 2 AAA batteries, inserting them in their correct orientations.
4. Insert the electronics back into the brush handle so that the screw holes line up.
5. Insert and tighten the small screw.

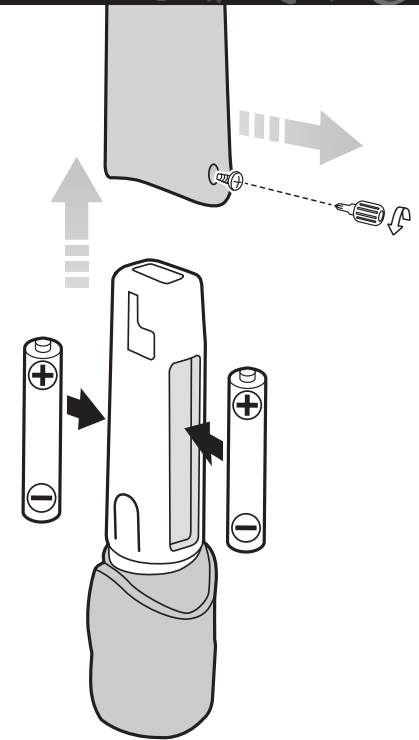

IMPORTANT BATTERY INFORMATION:

- Use only fresh batteries of the required size and recommended type.
- Do not mix old and new batteries, different types of batteries [standard (Carbon-Zinc), Alkaline or rechargeable] or rechargeable batteries of different capacities.
- Remove rechargeable batteries from the toothbrush before recharging them.
- Rechargeable batteries are only to be charged under adult supervision.
- Please respect the correct polarity, (+) and (-).
- Do not try to recharge non-rechargeable batteries.
- Do not dispose of batteries into fire.
- Replace all batteries of the same type/brand at the same time.
- The supply terminals are not to be short-circuited.
- Remove exhausted batteries from the toothbrush.
- Batteries should be replaced by adults.
- Batteries should be recycled or disposed of as per state and local guidelines.
- Protect the environment by not disposing of this product with household waste. Check your local authority for recycling advice and facilities.

